



DEEP WATER

Wide range of deep water and ultra deep water floats



**PREMIUM
QUALITY** 

Deep water floats for Single Point Mooring Systems, FPSO and FSO

Resinex has developed Deep Water Floats for Single Point Mooring Systems since the early seventies. Previously manufactured in PVC then developed using roto-moulded linear polyethylene, they operate on Calm buoys (Lazy-S or Chinese Lantern configurations) or SALM buoys and now also on FPSO and FSO Systems. Resinex products always comply with OCIMF GMPHOM 2009 rules.

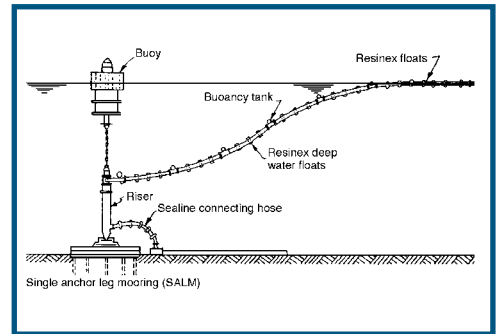
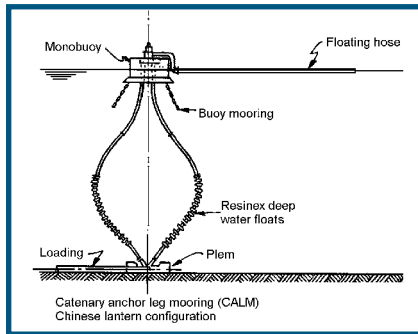
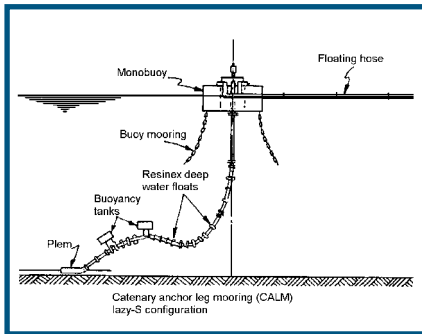

Resinex manufactures three different types of deep water floats for Single Point Mooring Systems and FPSO-FSO Systems with various characteristics and performances. The standard floats cover a range of internal diameter adaptations from 240 mm to 970 mm and a range of net buoyancy from 32 kg to 430 kg.

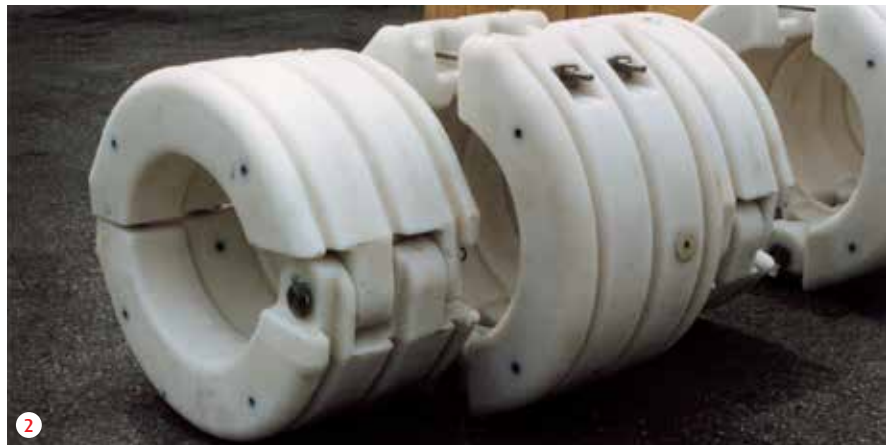
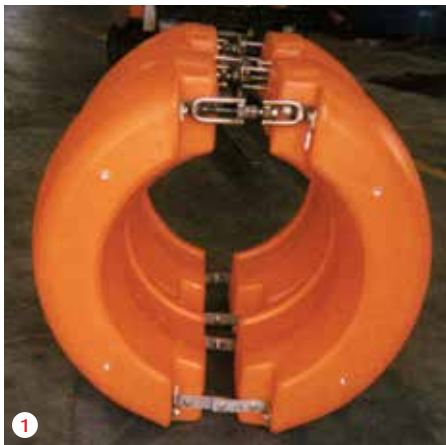

- ① **Hinged type:** high assembling angle; high adaptation at oil pumping pressure; wide range of diameters and net buoyancy.
- ② **Grooved type:** super strong-heavy duty performance, simple metallic part; high buoyancy.
- ③ **Bolted type:** high strength; high hydrodynamicity; simple metallic part.

Hinged type

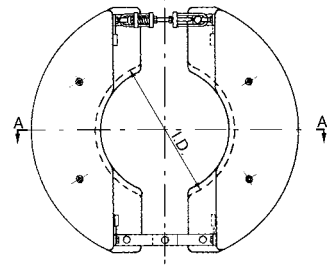
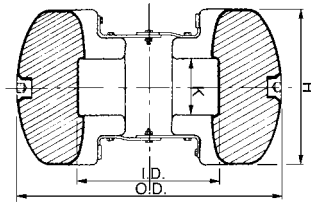

HINGED TYPE	SIZE mm.						WATER DEPTH			
	O.D.	I.D.	H	K	ADJUSTABLE RANGE I.D.		0+40m.		40+80m.	
							Weight Kg.	N.B. Kg.	Weight Kg.	N.B. Kg.
06" BODY	630	250	330	205	240	270	30	32	32	30
06" END - 08" BODY	630	310	330	205	270	340	21	41	26	36
08" END - 10" BODY	700	360	350	205	340	400	25	55	32	48
10" END - 12" BODY	780	420	400	205	410	440	35	76	43	68
12" EXTRA	940	495	550	205	445	520	58	123	70	111
12" END - 16" BODY	940	520	550	205	500	550	61	153	74	140
16" END - 20" BODY	1060	620	540	205	530	660	72	184	84	172
20" EXTRA	1250	800	600	205	785	840	107	273	124	256
20" END - 24" BODY	1160	700	600	205	620	785	89	231	104	216
24" END	1350	876	600	205	876	910	109	291	137	263

Grooved type

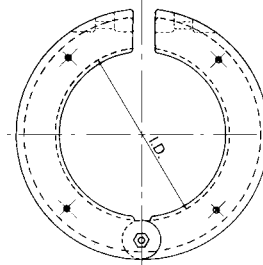
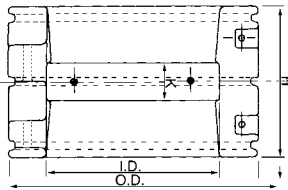

GROOVED TYPE	SIZE mm.						WATER DEPTH			
	O.D.	I.D.	H	K	ADJUSTABLE RANGE I.D.		0+40m.		40+80m.	
							Weight Kg.	N.B. Kg.	Weight Kg.	N.B. Kg.
16" END - 20" BODY	1050	640	550	205	640	697	73	168	90	151
20" END - 24" BODY	1200	640	600	205	700	832	95	267	120	242
24" EXTRA	1370	940	800	205	860	970	138	430	190	376

Bolted type

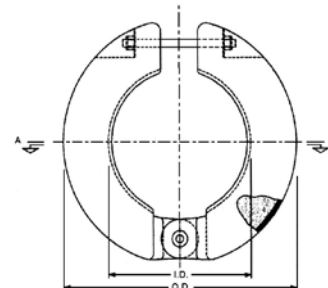
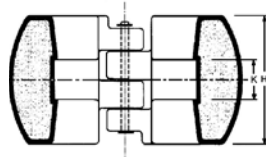

BOLTED TYPE	SIZE mm.						WATER DEPTH			
	O.D.	I.D.	H	K	ADJUSTABLE RANGE I.D.		0+40m.		40+80m.	
							Weight Kg.	N.B. Kg.	Weight Kg.	N.B. Kg.
12" HE - 16" HB	971	530	550	205	450	550	68	140	81	127
24" HE	1390	876	600	205	750	890	122	312	162	272

N.B.: the buoyancy is considered in fresh water. - K: the width collar range can be adapted to every hose float mount from 135 to 205 mm. Water depth: higher depth (till 7.000 mts.) can be reached, weight will be higher, net buoyancy reduced.

Assembling and use

Resinex deep water floats are studied to give the best tightening performance on the float mounts of hoses and on the clamps of risers. Tightening can be obtained directly or through rotomoulded reducers assembled on the float itself. Their particular shape has been studied to allow the higher bending of hoses and risers. The hinged solution adopted by each Resinex type of floats, maximized by the Hinged Type, facilitates all the assembling procedures that can be made also underwater. In case of underwater installation, Resinex supplies plate sinkers to give neutral buoyancy to the float.

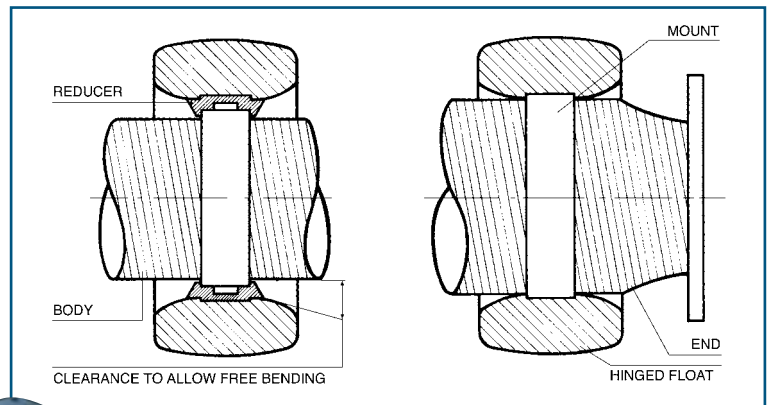

Right: plate sinkers for underwater assembly.

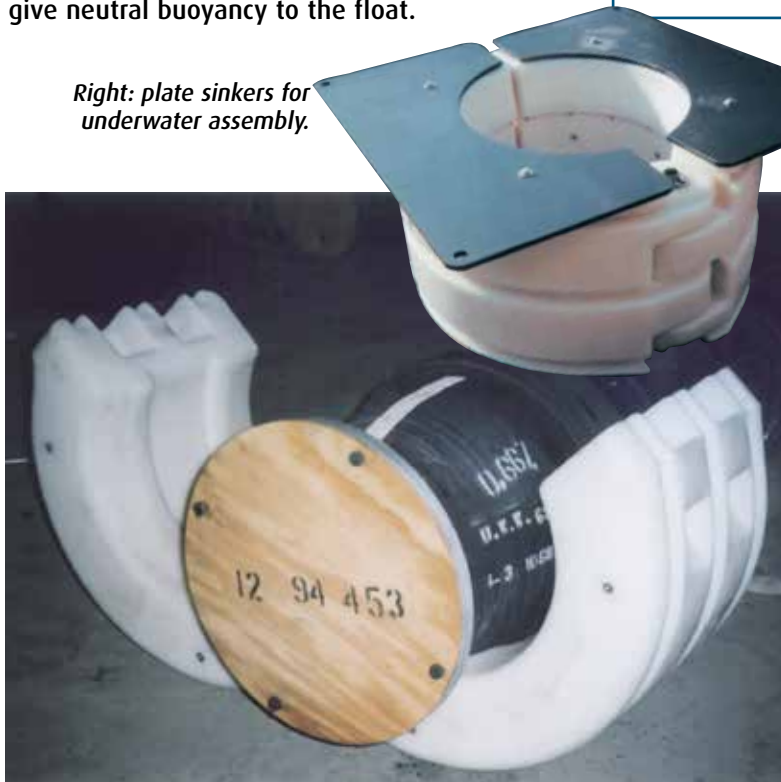

Also supports for umbilicals can be easily installed on Resinex Deep Water Floats.

Easy installation around float mount.



Assembling test of a complete float set for rubber hose in house.



Resinex hinged floats in operation in blue sea.

Ultra Deep water

The continuous development of new technology allows Resinex to utilize the most up-to-date materials and components and thanks to diverse density, buoys are able to function to a depth of 11 thousands metres.

With the innovative Nautex (Glassfoam) and Synt fillings, the ratio between pressure resistance and specific weight can arrive to a high level with a subsequent marked containment of price.

The tests carried out in the big pressure tanks at Resinex Marine Research Centre in Adro vouch the final result.

Besides floats and buoys for ultra deep water usage, the range of Resinex products is enriched by a full range of Riser Floats, Cable Floats and Umbilical Floats.





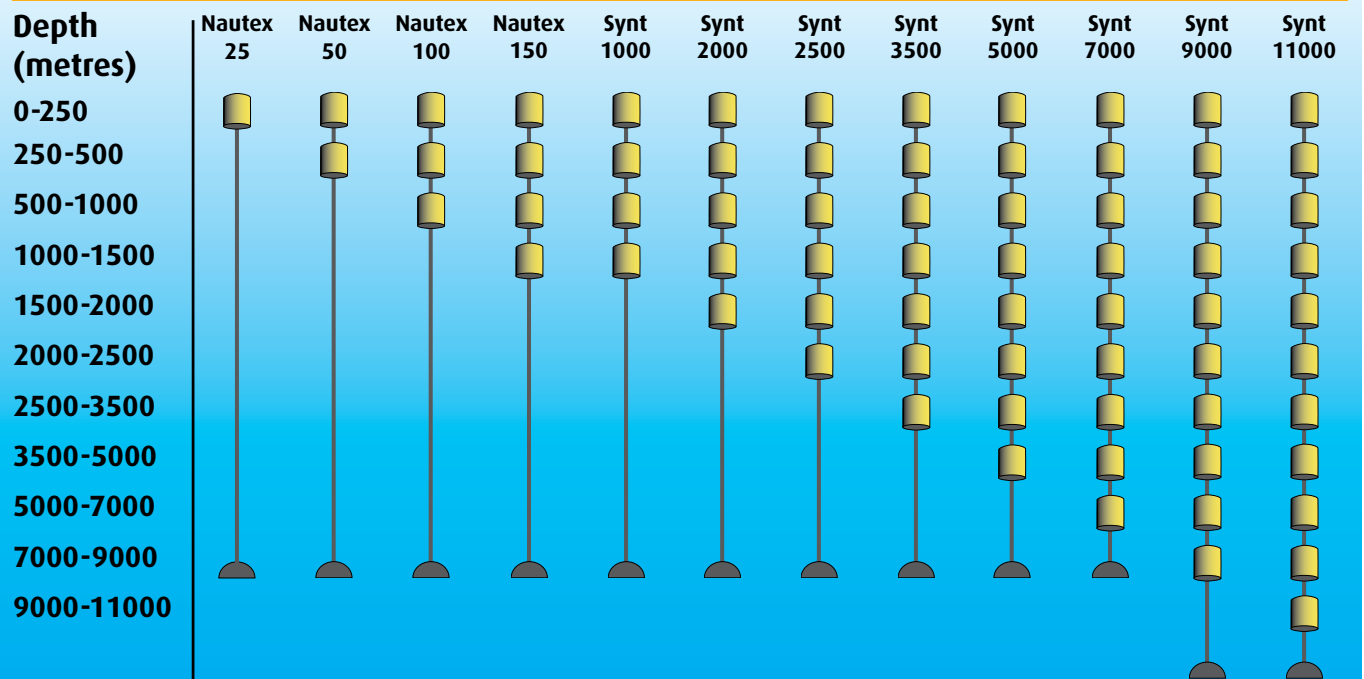

FROM ZERO TO 11000 METRES, RESINEX TECHNOLOGY FOR HIGH DEPTHS



Riser Floats

Resinex produces a full range of Riser Floats and protective Shims to be used during drilling operations. Following the experience of many different projects supplied around the world, the range of Buoyancy Modules used during installation or for permanent use is very wide. Buoyancy elements are always supplied with high performance steel clamps. This type of floats is normally installed between 1000 and 4000 metres water depth.

TYPE	RISER FLOATS: FROM 130 TO 2400 LITRES OF VOLUME			
	Øe (mm)	ØI (mm)	L (mm)	VOLUME (LITRES)
 	1450	560-565	1800	2370
 	1464	500-550	2000	2130
 	1450	250-350	1100	1630
 	1404	500-550	2210	1290
 	950	50-100	2200	1230
 	1500	500-650	750	1090
 	1100	200-300	1200	1020
 	1000	200-250	1200	830
 	1000	200-300	1100	700
 	1000	100-200	1000	700
 	550	100-200	650	130



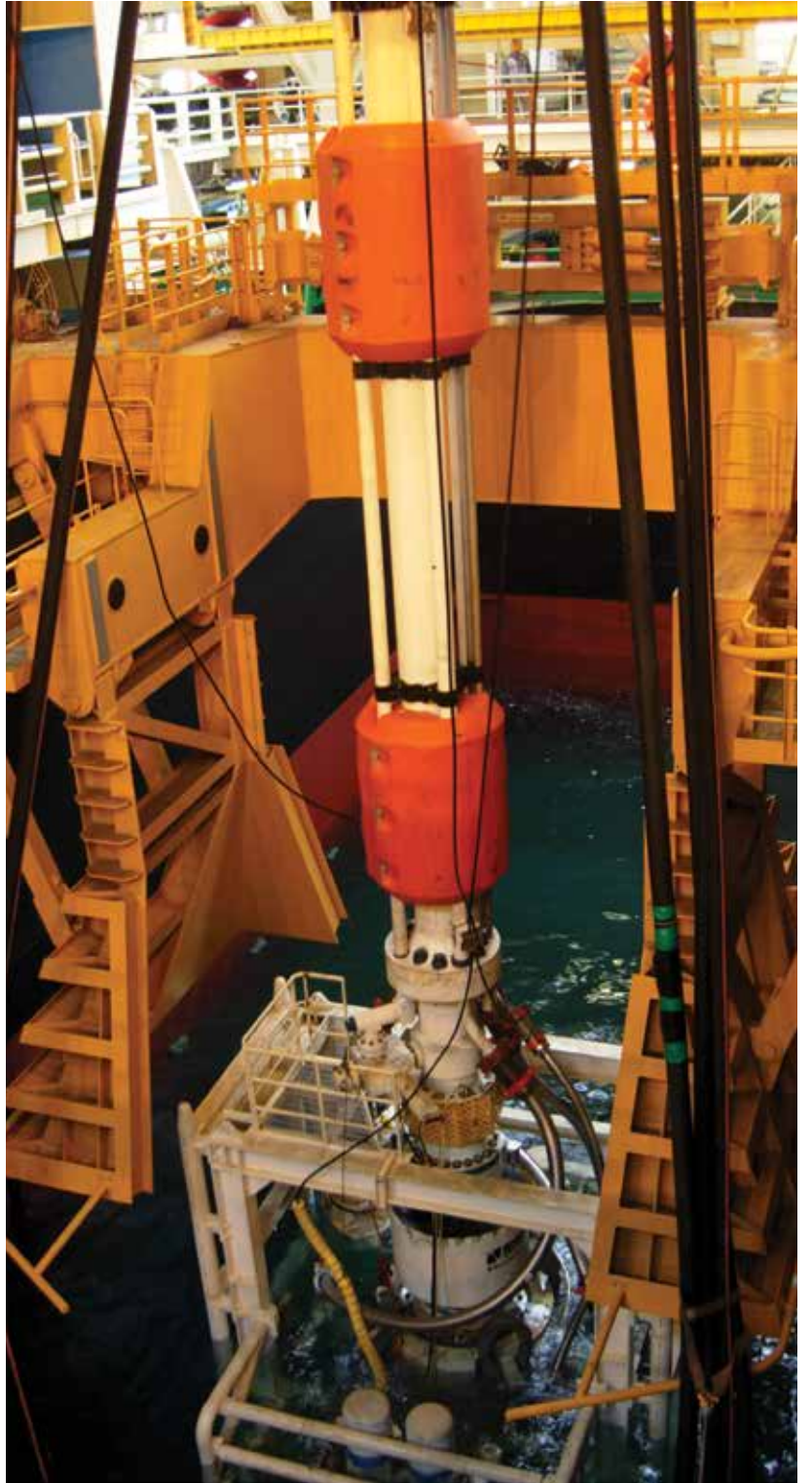





Cable and Umbilical Floats

Not only hoses but also cables, ropes and umbilicals need to be lightened under water. Resinex gives a complete range of floats with reduced diameters to its customers.

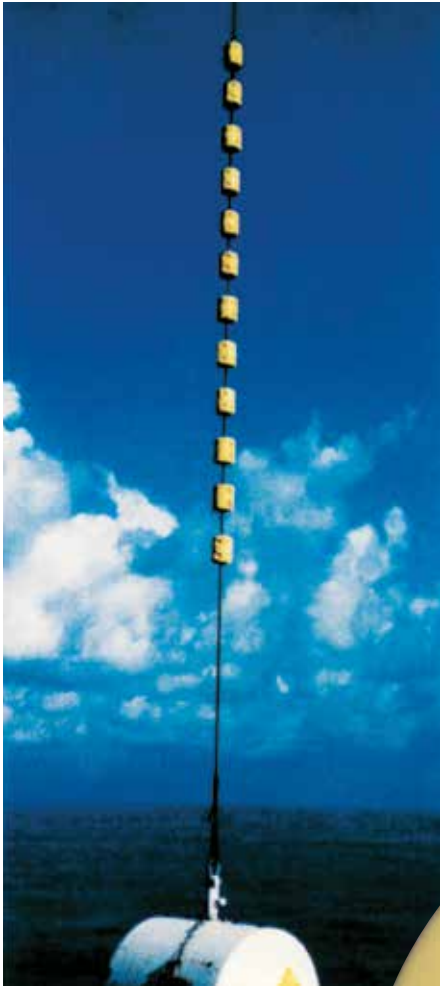
The key success factor of this activity is tightening. The floats cannot slip on the cable once assembled.

Resinex has developed particular polyurethane clamps and reducers to maximize the grip on the cable surface. Particular studies have been carried on to give our products the best mixture between loads, weight of materials and tightening forces. Now we can supply different solutions to guarantee the higher tightening force together with the usual high resistance to pressure until a 11,000 metres depth.



TYPE	CABLE FLOATS: FROM 1,7 TO 50 KG OF NETT BUOYANCY DEPTH/METRES				
	Øe (mm)	ØI (mm)	L (mm)	0-50	50-100
				N.B./kg	
	450	65-175	550	50	38
	420	20-105	600	45	35
	150	15-60	300	2,1	1,7

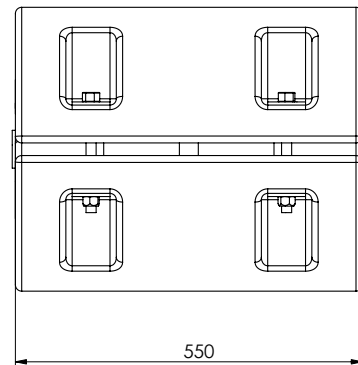
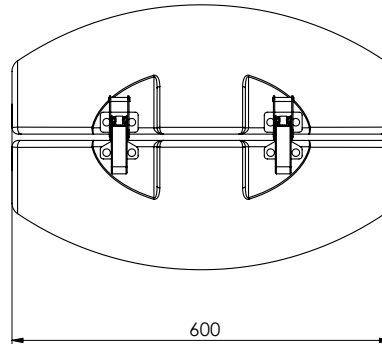
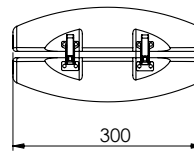
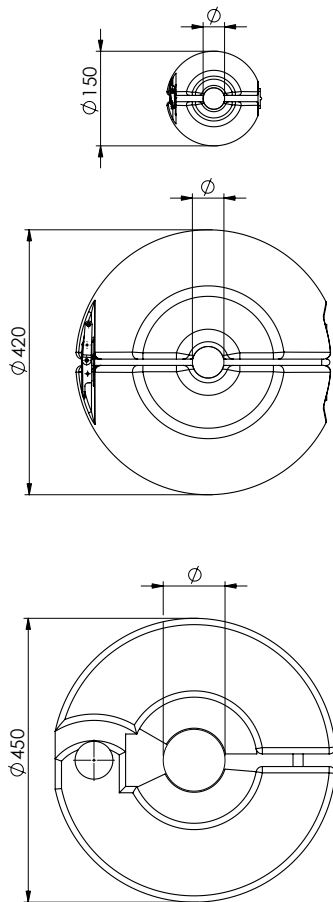

Quality control and tests

Deep waters are not a friendly environment. Being aware of this, Resinex produces deep water floats, monitoring every step of the manufacturing plan. Starting from rotomoulding polyethylene thickness, passing through the quality control of AISI 316 or Titanium metallic part Resinex Quality Assurance Department finally arrives at the strict controls of Nautex (Glassfoam) compounds or Syntactic foam filling.

Resinex, with its products, has always anticipated market needs and invested hefty sums in research thereby always keeping one step ahead of the competition: an example of this is the set of six autoclaves installed in the Adro Marine Research Centre.

There is an autoclave which is able to run pressure resistance tests up to 850 bars, the equivalent of 8500 metres depth under sea level (underneath).

No other similar autoclave exists in continental Europe.

Among the other autoclaves available for Resinex laboratory technicians, there is a giant of 2.1 metres in diameter by 3.5 metres in height which can simulate pressure conditions of up to depths of 500 metres.

In this way our company is once again the vanguard in quality and safety

in its floats, offering an always more advanced service to the customer.

Quality Management of materials and production process is certified by Lloyd's Register Quality Assurance norm ISO 9001:2000.

Exhaustive laboratory tests are carried out on samples taken during the work process. But before being consigned, the floats that come off the production line in Torbiato (Brescia) are first passed through to the nearby Adro Resinex Marine Research Centre which is equipped with the most up-to-date and sophisticated analysis systems. Besides weight and dimension, traction resistance is tested, both of pressure and floatability (net buoyancy) and the data are fed into a computerized system which gives a report of all the characteristics of the piece in question. This is a type of Identity Card which represents an extra guarantee of Resinex quality.

- 1 *Traction strength test on hinged floats.*
- 2 *Weight procedures at electronic scales.*
- 3 *High pressure tests in the Adro Resinex Marine Research Centre.*



» Hydrostatic Pressure Test in 6 pressure tanks till 850 bars



» Buoyancy Test

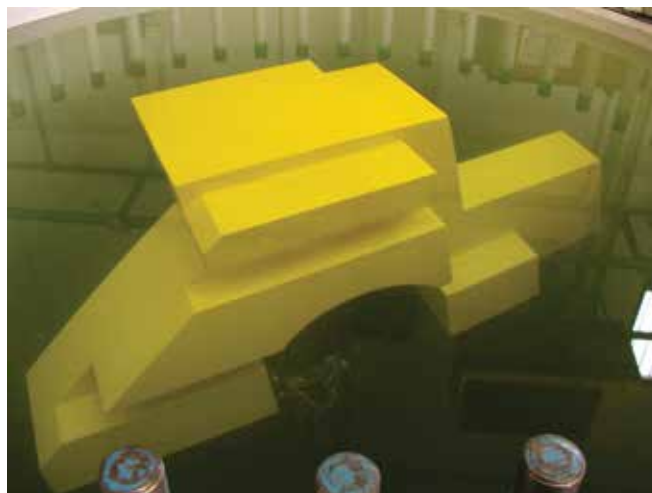

» Infra-red analysis of synt foam filling

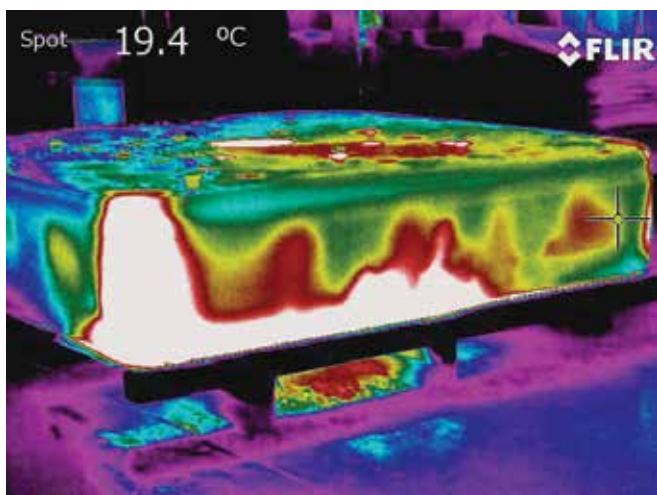

» Fastening Removal Test on Pipe Floats



» Structural Pressure Test on the buoy body

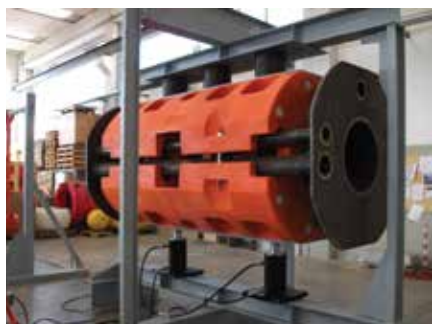

» Impact Test on the buoy body



» Tension Test on float assembly



» Proof Load Test on steel parts



» Crash Test on buoyancy elements



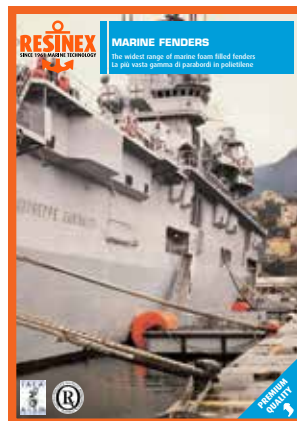

Resinex Trading S.r.l
Via Cappuccio, 14 - 20123 Milan, Italy

Milan Office
Ph +39.02.7201 3463
Fax +39.02.7201 6182
marketing@resinextrad.com

Adro (BS)
Via Laveni, 14
Ph +39.030.745 1194
r&d@resinextrad.com

Torbiato di Adro (BS)
Via Artigiani, 15
Ph +39.030.745 7245
production@resinextrad.com
marketing@resinextrad.com

Resinex Asia
sales@resinexasia.com

www.resinextrad.com